

Data Sheet



Article number: 021816011304

Description: Clamp with bracket and rubber
SPGU 6011. 304/30 SK

Measures

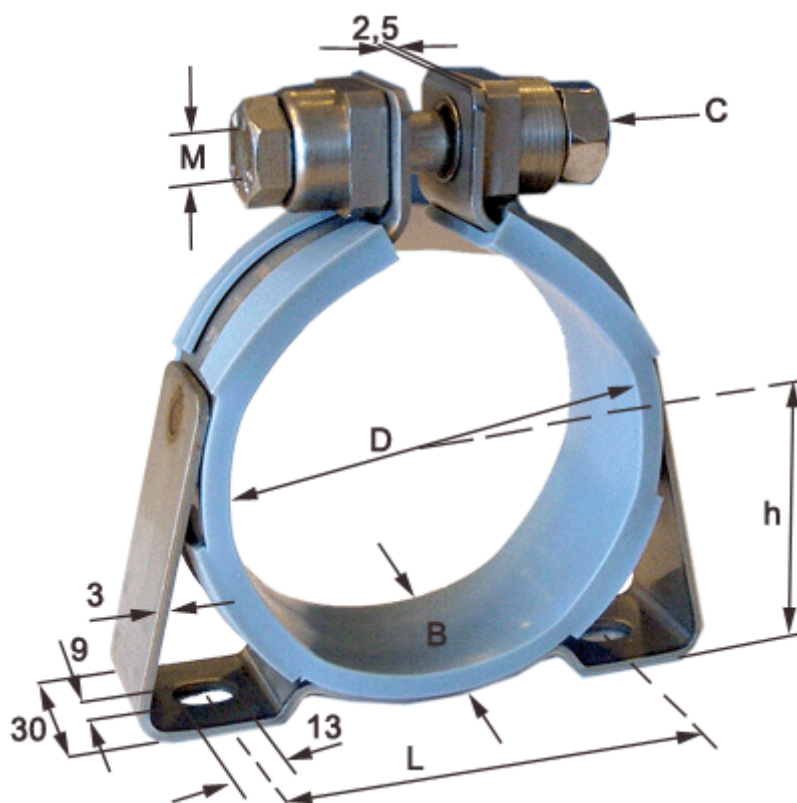

C (screw type) = SK hexagon screw

Diameter D = 304

h = 160

L = 280

Width B = 30